

 info@bike-systems.com

 +48 887 026 136

High/ Low Bike rack

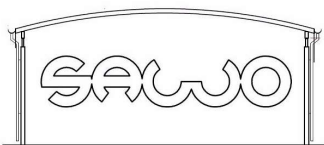

✉ info@bike-systems.com

☎ +48 887 026 136



Specification

Material:

High-quality structural steel,

Corrosion protection:

The steel stands are hot-dip galvanised in accordance with ISO EN 1461, this is the best technology to protect the steel structure against corrosion, erosion and damage.

Powder coating:

The steel structure can be electrostatically powder coated in any colour from the standard RAL palette.

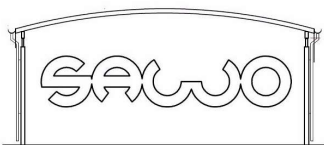

info@park4bike.pl



+48 887 026 136

Drawings

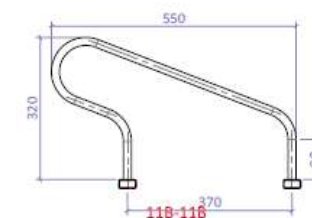
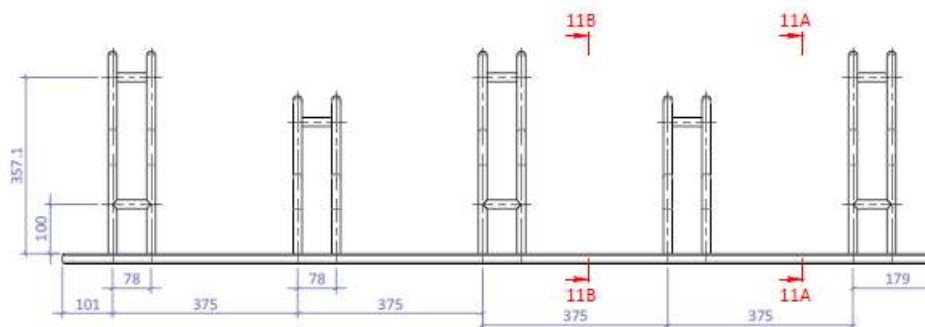
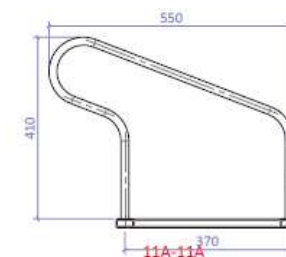
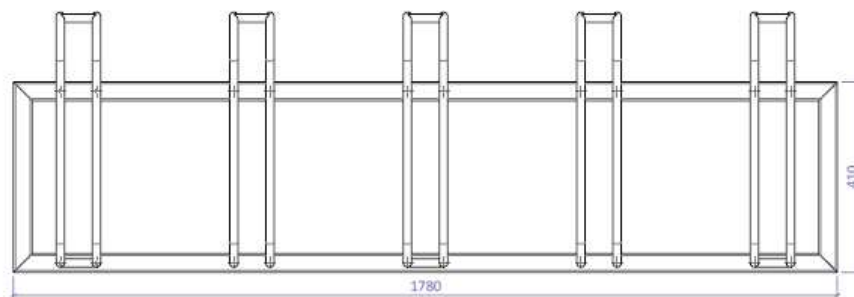
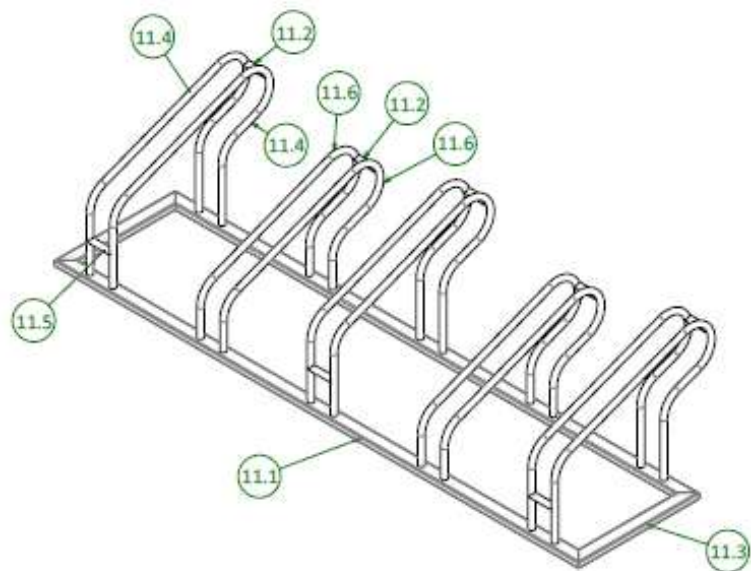

NR	NAZWA	OPIS	Nr Kat.	ILOŚĆ
11	STOJAK ROWEROWY	wysoko/nisko	-	1
11.1		RHS 40 x 20 x 2		2
11.2		Rura $\phi 18 \times 1.5$		7
11.3		RHS 40 x 20 x 2		2
11.4		Rura $\phi 18 \times 1.5$		8
11.5		Rura $\phi 18 \times 1.5$		4
11.6		Rura $\phi 18 \times 1.5$		6

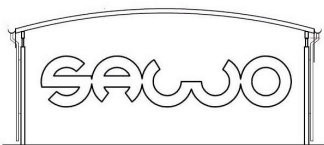

✉ info@bike-systems.com

☎ +48 887 026 136

Realisations



HDG + Powder coating



HDG